

# **POOLEX**

## Vertex **FI**

1 / 2 / 3 / 4 / 5 / 6

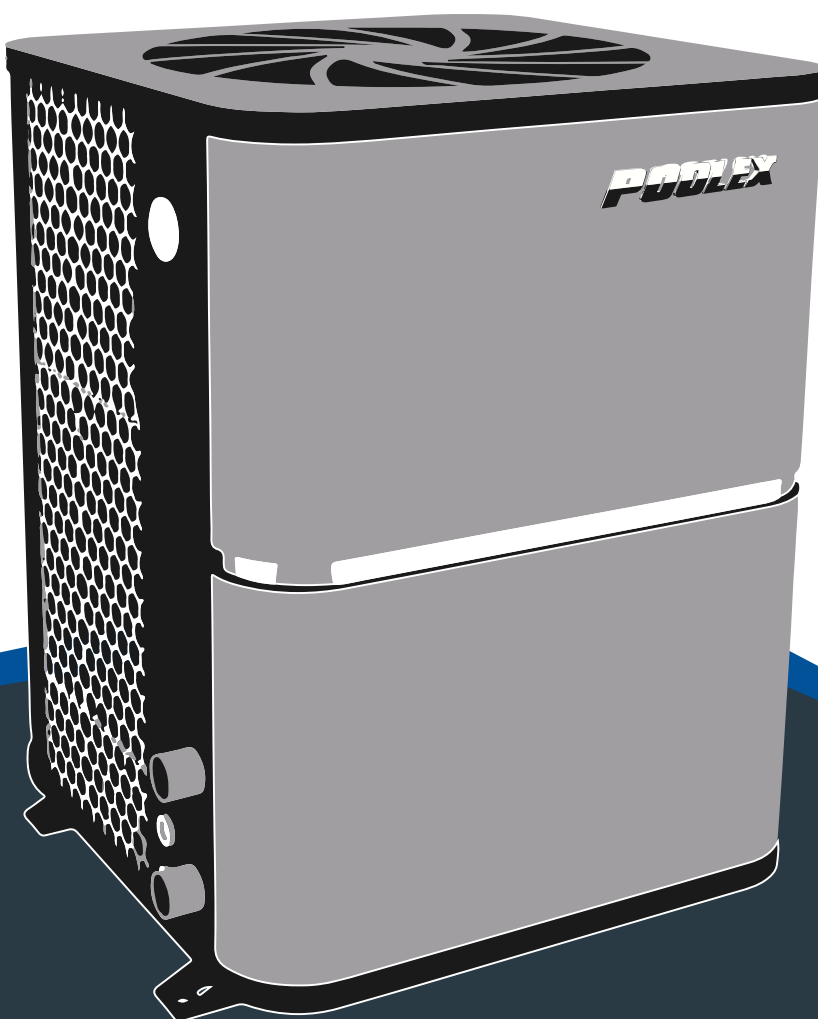

# INSTALLATION AND USER MANUAL

for your heat pump

# Warning



***This heat pump contains a flammable refrigerant R32.***

***Any intervention on the refrigerant circuit is prohibited without a valid authorization.***

***Before working on the refrigerant circuit, the following precautions are necessary for safe work.***

## **1. Work procedure**

*The work must be carried out according to a controlled procedure, in order to minimize the risk of presence of flammable gases or vapors during the execution of the works.*

## **2. General work area**

*All persons in the area must be informed of the nature of the work in progress. Avoid working in a confined area. The area around the work area should be divided, secured and special attention should be paid to nearby sources of flame or heat.*

## **3. Verification of the presence of refrigerant**

*The area should be checked with a suitable refrigerant detector before and during work to ensure that there is no potentially flammable gas. Make sure that the leak detection equipment used is suitable for flammable refrigerants, ie it does not produce sparks, is properly sealed or has internal safety.*

## **4. Presence of fire extinguisher**

*If hot work is to be performed on the refrigeration equipment or any associated part, appropriate fire extinguishing equipment must be available. Install a dry powder or CO2 fire extinguisher near the work area.*

## **5. No source of flame, heat or spark**

*It is totally forbidden to use a source of heat, flame or spark in the direct vicinity of one or more parts or pipes containing or having contained a flammable refrigerant. All sources of ignition, including smoking, must be sufficiently far from the place of installation, repair, removal and disposal, during which time a flammable refrigerant may be released into the surrounding area. Before starting work, the environment of the equipment should be checked to ensure that there is no risk of flammability. «No smoking» signs must be posted.*

## **6. Ventilated area**

*Make sure the area is in the open air or is properly ventilated before working on the system or performing hot work. Some ventilation must be maintained during the duration of the work.*

## **7. Controls of refrigeration equipment**

*When electrical components are replaced, they must be suitable for the intended purpose and the appropriate specifications. Only the parts of the manufacturer can be used. If in doubt, consult the technical service of the manufacturer.*

*The following controls should be applied to installations using flammable refrigerants:*

- The size of the load is in accordance with the size of the room in which the rooms containing the refrigerant are installed;*
- Ventilation and air vents work properly and are not obstructed;*
- If an indirect refrigeration circuit is used, the secondary circuit must also be checked.*
- The marking on the equipment remains visible and legible. Illegible marks and signs must be corrected;*
- Refrigeration pipes or components are installed in a position where they are unlikely to be exposed to a substance that could corrode components containing refrigerant*

## **8. Verification of electrical appliances**

*Repair and maintenance of electrical components must include initial safety checks and component inspection procedures. If there is a defect that could compromise safety, no power supply should be connected to the circuit until the problem is resolved.*

*Initial security checks must include:*

- That the capacitors are discharged: this must be done in a safe way to avoid the possibility of sparks;*
- No electrical components or wiring are exposed during loading, recovery or purging of the refrigerant gas system;*
- There is continuity of grounding.*

# Thank you

*Dear Customer,*

*Thank you for your purchase and for your confidence in our products.*

*These are the result of many years of research in the field of design and production of heat pumps for swimming pools. Our aim is to provide you with an exceptional high performance quality product.*

*We have produced this manual with the utmost care so that you get maximum benefit from your Poolex heat pump.*

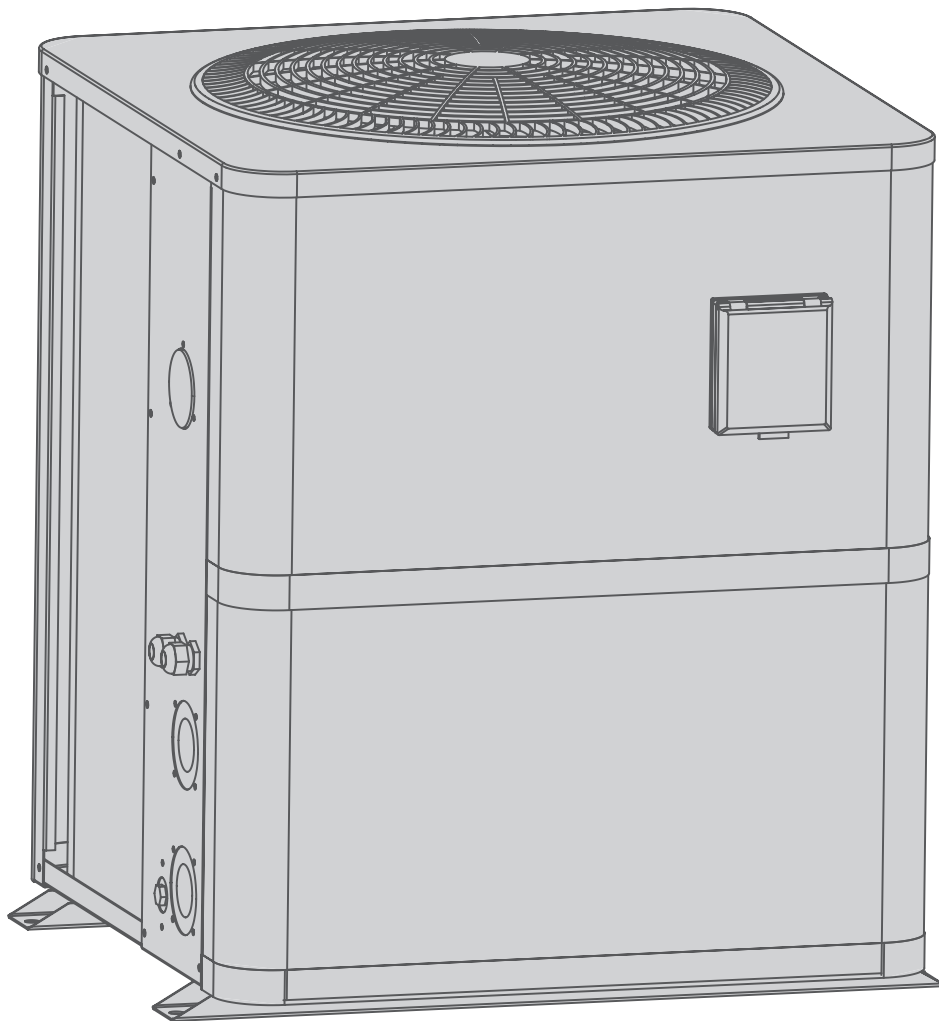



# PLEASE READ CAREFULLY.



**These installation instructions are an integral part of the product.  
They must be given to the installer and retained by the user.  
If the manual is lost, please consult the website:**

The instructions and recommendations contained in this manual should be read carefully and understood since they provide valuable information concerning the heat pump's safe handling and operation. **Keep this manual in an accessible place for easy future reference.**

**Installation must be carried out by a qualified professional person** in accordance with current regulations and the manufacturer's instructions. An installation error may cause physical injury to persons or animals as well as mechanical damage for which the manufacturer can under no circumstances be held responsible.

**After unpacking the heat pump, please check the contents in order to report any damage.**

Prior to connecting the heat pump, ensure that the information provided in this manual is compatible with the actual installation conditions and does not exceed the maximum limits authorised for this particular product.

**In the event of a defect and/or malfunction of the heat pump, the electricity supply must be disconnected** and no attempt made to repair the fault.

Repairs must be undertaken only by an authorised technical service organisation using original replacement parts. Failure to comply with the above-mentioned clauses may have an adverse effect on the heat pump's safe operation.

To guarantee the heat pump's efficiency and satisfactory operation, it is important to ensure its regular maintenance in accordance with the instructions provided.

If the heat pump is sold or transferred, always make sure that all technical documentation is transmitted with the equipment to the new owner.

This heat pump is designed solely for heating a swimming pool. Any other use must be considered as being inappropriate, incorrect or even hazardous.

Any contractual or non-contractual liability of the manufacturer/distributor shall be deemed null and void for damage caused by installation or operational errors, or due to non-compliance with the instructions provided in this manual or with current installation norms applicable to the equipment covered by this document.

# Contents

<b>1.</b>	<b>General</b>	<b>6</b>
1.1	General Terms of Delivery	6
1.2	Safety instructions	6
1.3	Water treatment	7
<b>2.</b>	<b>Description</b>	<b>8</b>
2.1	Package contents	8
2.2	General characteristics	8
2.3	Technical specifications	9
2.4	Unit dimensions	10
2.5	Exploded view Vertex 1 / 2	11
2.5	Exploded view Vertex 3 / 4 / 5	13
<b>3.</b>	<b>Installation</b>	<b>14</b>
3.1	Pre-requirements	14
3.2	Location	14
3.3	Installation layout	15
3.4	Connecting the condensation draining kit	15
3.5	Installing the unit on noise-damping supports	15
3.6	Hydraulic connection	16
3.7	Electrical installation	18
3.8	Electrical connection	19
<b>4.</b>	<b>Use</b>	<b>20</b>
4.1	Wired remote control	20
4.2	Operating mode selector	21
4.3	Operating modes	21
4.4	LED intelligent system	
4.5	Choice of operating mode	22
4.6	Setting the set temperature	22
4.7	Clock Setting	23
4.8	On / Off synchronization adjustment	23
4.9	Activation / deactivation of On / Off groups	24
4.10	Main parameters	24
4.11	State values	25
<b>5.</b>	<b>Operation</b>	<b>26</b>
5.1	Operation	26
5.2	Servo-control of circulating pump	26
5.3	Using the pressure gauge	27
5.4	Antifreeze protection	27
<b>6.</b>	<b>Maintenance and servicing</b>	<b>28</b>
6.1	Maintenance and servicing	28
6.2	Winter storage	28
<b>7.</b>	<b>Repairs</b>	<b>29</b>
7.1	Breakdowns and faults	29
7.2	System parameter query	29
7.3	List of faults	30
<b>8.</b>	<b>Recycling</b>	<b>31</b>
8.1	Recycling the heat pump	31
<b>9.</b>	<b>Warranty</b>	<b>32</b>
9.1	General warranty conditions	32
<b>10.</b>	<b>Appendices</b>	<b>33</b>
10.1	Wiring diagrams	33

# 1. General

## 1.1 General Terms of Delivery

All equipment, even if shipped 'free of carriage and packing', is dispatched at the consignee's own risk

The person responsible for receiving the equipment must carry out a visual inspection to identify any damage to the heat pump during transport (refrigerant system, body panels, electrical control box, frame). He/she must note down on the carrier's delivery note any remarks concerning damage caused during transport and confirm them to the carrier by registered letter within 48 hours.

The equipment must always be stored and transported vertically on a pallet and in its original packaging. If



it is stored or transported horizontally, wait at least 24 hours before switching it on.

## 1.2 Safety instructions



**WARNING: Please read carefully the safety instructions before using the equipment. The following instructions are essential for safety so please strictly comply with them.**

### *During installation and servicing*

Only a qualified person may undertake installation, start-up, servicing and repairs, in compliance with current standards.

Before operating or undertaking any work on the equipment (installation, commissioning, usage, servicing), the person responsible must be aware of all the instructions in the heat pump's installation manual as well as the technical specifications.

Under no circumstances install the equipment close to a source of heat, combustible materials or a building's air intake.

If installation is not in a location with restricted access, a heat pump protective grille must be fitted.

To avoid severe burns, do not walk on pipework during installation, repairs or maintenance.

To avoid severe burns, prior to any work on the refrigerant system, turn off the heat pump and wait several minutes before placing temperature and pressure sensors.

Check the refrigerant level when servicing the heat pump.

Check that the high and low pressure switches are correctly connected to the refrigerant system and that they turn off the electrical circuit if tripped during the equipment's annual leakage inspection.

Check that there is no trace of corrosion or oil stains around the refrigerant components.

# 1. General

## ***During use***

To avoid serious injuries, never touch the fan when it is operating.

Keep the heat pump out of the reach of children to avoid serious injuries caused by the heat exchanger's blades.

Never start the equipment if there is no water in the pool or if the circulating pump is stopped.

Check the water flow rate every month and clean the filter if necessary.

## ***During cleaning***

Switch off the equipment's electricity supply.

Close the water inlet and outlet valves.

Do not insert anything into the air or water intakes or outlets.

Do not rinse the equipment with water.

## ***During repairs***

Carry out work on the refrigerant system in accordance with current safety regulations.

Brazing should be performed by a qualified welder.

When replacing a defective refrigerant component, use only parts certified by our technical department.

When replacing pipework, only copper pipes conforming to Standard NF EN12735-1 may be used for repairs.

When pressure-testing to detect leaks:

To avoid the risks of fire or explosion, never use oxygen or dry air.

Use dehydrated nitrogen or a mixture of nitrogen and refrigerant.

The low and high side test pressure must not exceed 42 bar.

## **1.3 Water treatment**

Poolex heat pumps for swimming pools can be used with all types of water treatment systems.

Nevertheless, it is essential that the treatment system (chlorine, pH, bromine and/or salt chlorinator metering pumps) is installed after the heat pump in the hydraulic circuit.

**To avoid any deterioration to the heat pump, the water's pH must be maintained between 6.9 and 8.0.**

# 2. Description

## 2.1 Package contents

- ✓ Heat pump Poolex Vertex Fi
- ✓ 2 hydraulic inlet/outlet connectors (50mm diameter)
- ✓ Extension cable for remote control panel
- ✓ This installation and user manual
- ✓ Condensation draining kit
- ✓ Winter storage cover
- ✓ 4 anti-vibration pads (fastenings not supplied)

## 2.2 General characteristics

A Poolex heat pump has the following features:

- ◆ CE certification and complies with the RoHS European directive.
- ◆ High performance with up to 80% energy savings compared to a conventional heating system.
- ◆ Clean, efficient and environmentally friendly R32 refrigerant.
- ◆ Reliable high output leading brand compressor.
- ◆ Wide hydrophilic aluminium evaporator for use at low temperatures.
- ◆ User-friendly intuitive remote control.
- ◆ Designed to be silent.
- ◆ Dual antifreeze system to avoid frost damage:
  - Revolutionary exchanger with patented antifreeze system.
  - A smart monitoring system to preserve the pipework and liner without emptying the pool in winter.



# 2. Description

## 2.3 Technical specifications

Test conditions	Poolex Vertex Fi						
	1	2	3	4	5	6	
Air <sup>(1)</sup> 26°C Water <sup>(2)</sup> 26°C INVERTER MODE	Heating power (kW)	7.58~1.73	10.22~2.33	13.22~3.01	16.83~3.83	21.54~4.89	28.65~6.58
	Consumption (kW)	1.09~0.11	1.47~0.15	1.90~0.19	2.42~0.24	3.10~0.30	4.10~0.41
	<b>COP (Coeff. of performance)</b>	16.02~6.93	16.06~6.94	16.09~6.96	16.14~6.96	16.11~6.95	16.15~6.98
Air <sup>(1)</sup> 26°C Water <sup>(2)</sup> 26°C SILENCE MODE	Heating power (kW)	6.49 ~1.73	8.70~2.33	11.23~3.01	14.32~3.83	18.38~4.89	24.35~6.58
	Consumption (kW)	0.86~0.11	1.15~0.15	1.45~0.19	1.85~0.24	2.41~0.30	3.10~0.41
	<b>COP (Coeff. of performance)</b>	16.02~7.55	16.06~7.57	16.09~7.74	16.14~7.74	16.11~7.63	16.15~7.85
Air <sup>(1)</sup> 15°C Water <sup>(2)</sup> 26°C INVERTER MODE	Heating power (kW)	5.84~1.33	7.85~1.79	9.85~2.24	12.82~2.92	15.92~3.61	20.88~4.75
	Consumption (kW)	1.18~0.18	1.58~0.24	1.98~0.29	2.57~0.38	3.20~0.48	4.18~0.62
	<b>COP (Coeff. of performance)</b>	7.58~4.95	7.61~4.96	7.62~4.97	7.63~4.98	7.59~4.97	7.64~4.99
Air <sup>(1)</sup> 15°C Water <sup>(2)</sup> 26°C SILENCE MODE	Heating power (kW)	4.96~1.33	6.67~1.79	8.37~2.24	10.91~2.92	13.53~3.61	17.75~4.75
	Consumption (kW)	0.89~0.13	1.20~0.24	1.51~0.29	1.95~0.38	2.43~0.48	3.18~0.62
	<b>COP (Coeff. of performance)</b>	7.58~5.57	7.61~5.56	7.62~5.54	7.63~5.59	7.59~5.57	7.64~5.58
Air <sup>(1)</sup> 15°C Water <sup>(2)</sup> 26°C FIX MODE	Heating power (kW)	3,99	5,42	6,81	8,85	10,98	14,41
	Consumption (kW)	0,70	0,93	1,17	1,52	1,89	2,47
	<b>COP (Coeff. of performance)</b>	5,70	5,83	5,82	5,82	5,81	5,83
Air <sup>(1)</sup> 35°C Water <sup>(2)</sup> 27°C	Cooling capacity (kW)	4.26~1.14	5.49~1.51	7.01~1.92	9.05~2.47	11.15~2.89	15.25~3.92
	Consumption (kW)	1.17~0.17	1.50~0.23	1.92~0.29	2.46~0.37	3.06~0.44	4.16~0.59
	<b>Avg. EER (Energy Efficiency Ratio)</b>	6.62~3.63	6.63~3.65	6.65~3.66	6.65~3.68	6.62~3.64	6.69~3.67
Maximum power (kW)	1,85	2,68	3,65	4,06	4,65	6,26	
Maximum current (A)	8,4	12,1	16,4	18	20,6	27,9	
Electricity supply	220~240V/50Hz						
Protection							
Heating temperature range	15°C~40°C						
Cooling temperature range	7°C~35°C						
Operating temperature range	-15°C~43°C						
Unit dimensions L x W x H (mm)	414*414*576		552x525x641	652*625*741		742*716*935	
Unit weight (kg)	35	39	51	62	67	82	
Sound pressure level at 1 m (dBA) <sup>(3)</sup>	<36~<45	<37~<46	<39~<47	<40~<49	<41~<50	<42~<51	
Sound pressure level at 10 m (dBA) <sup>(3)</sup>	<19~<26	<20~<26	<20~<28	<21~<30	<23~<31	<24~<33	
Hydraulic connection (mm)	50mm (1"1/2)						
Heat exchanger	Cuve PVC et Serpentin Titane						
water flow rate (m³/h)	2,5	3,5	4,5	5,5	6,5	9	
Compressor	Mitsubishi						
Compressor type	Rotary			Twin Rotary			
Refrigerant	R32						
Load loss (mCE)	1	1	1	1,1	1,1	1,1	
Max. pool volume (m³) <sup>(4)</sup>	30-45	40-55	50-70	65-90	80-115	110-145	

The technical specifications of our heat pumps are provided for information purposes only. We reserve the right to make changes without prior notice.

<sup>1</sup> Ambient air temperature

<sup>2</sup> Initial water temperature

<sup>3</sup> Noise at 1 m, at 4 m and at 10 m in accordance with Directives EN ISO 3741 and EN ISO 354

<sup>4</sup> Calculated for an in-ground private swimming pool covered with a bubble cover in France

# 2. Description

## 2.4 Unit dimensions

### Vertex Fi 1 / 2

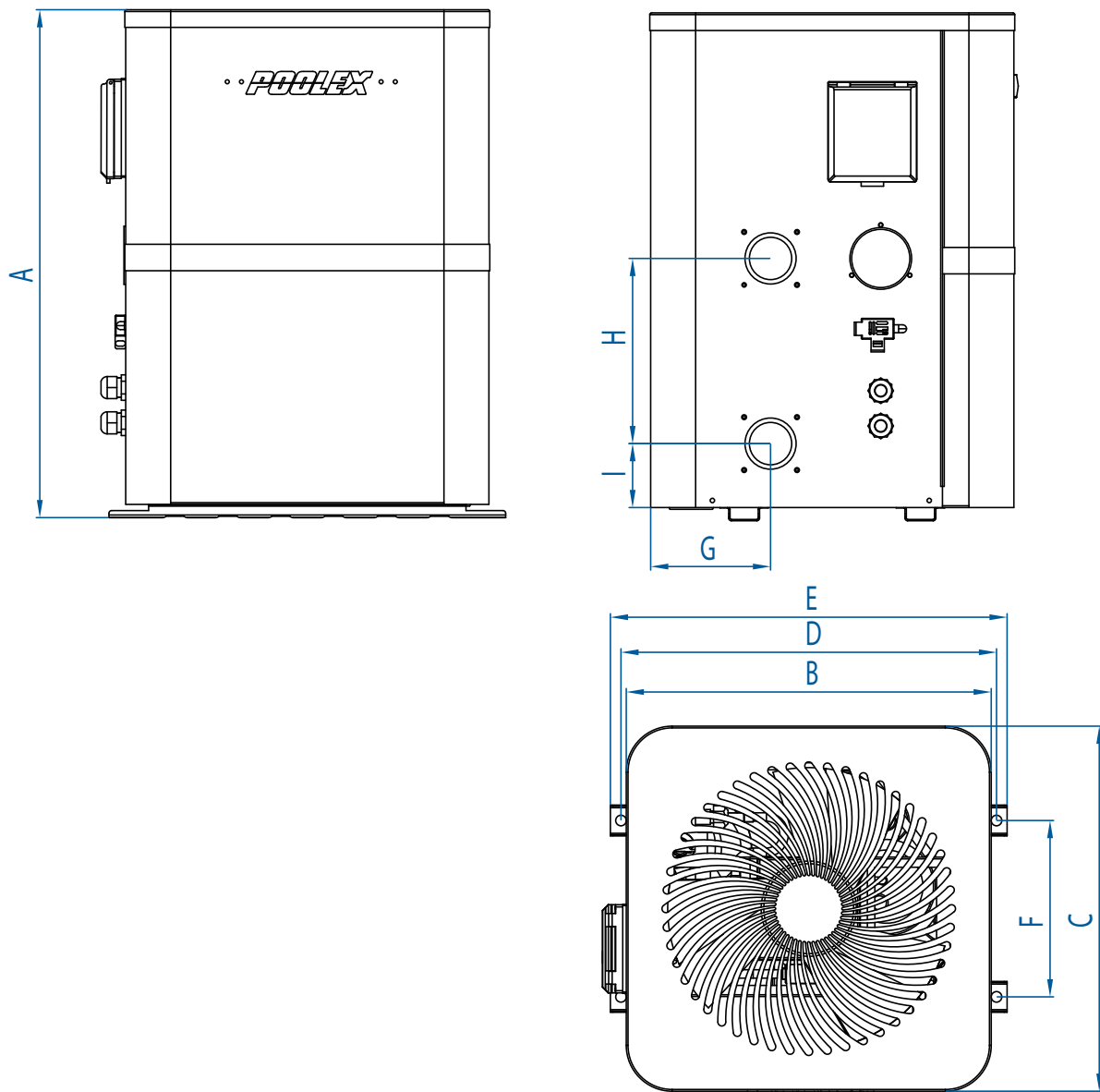

Model	1 / 2
A	576
B	414
C	414
D	426
E	450
F	200
G	151
H	6
I	72.5

# 2. Description

## 2.5 Exploded view

### Vertex Fi 1 / 2

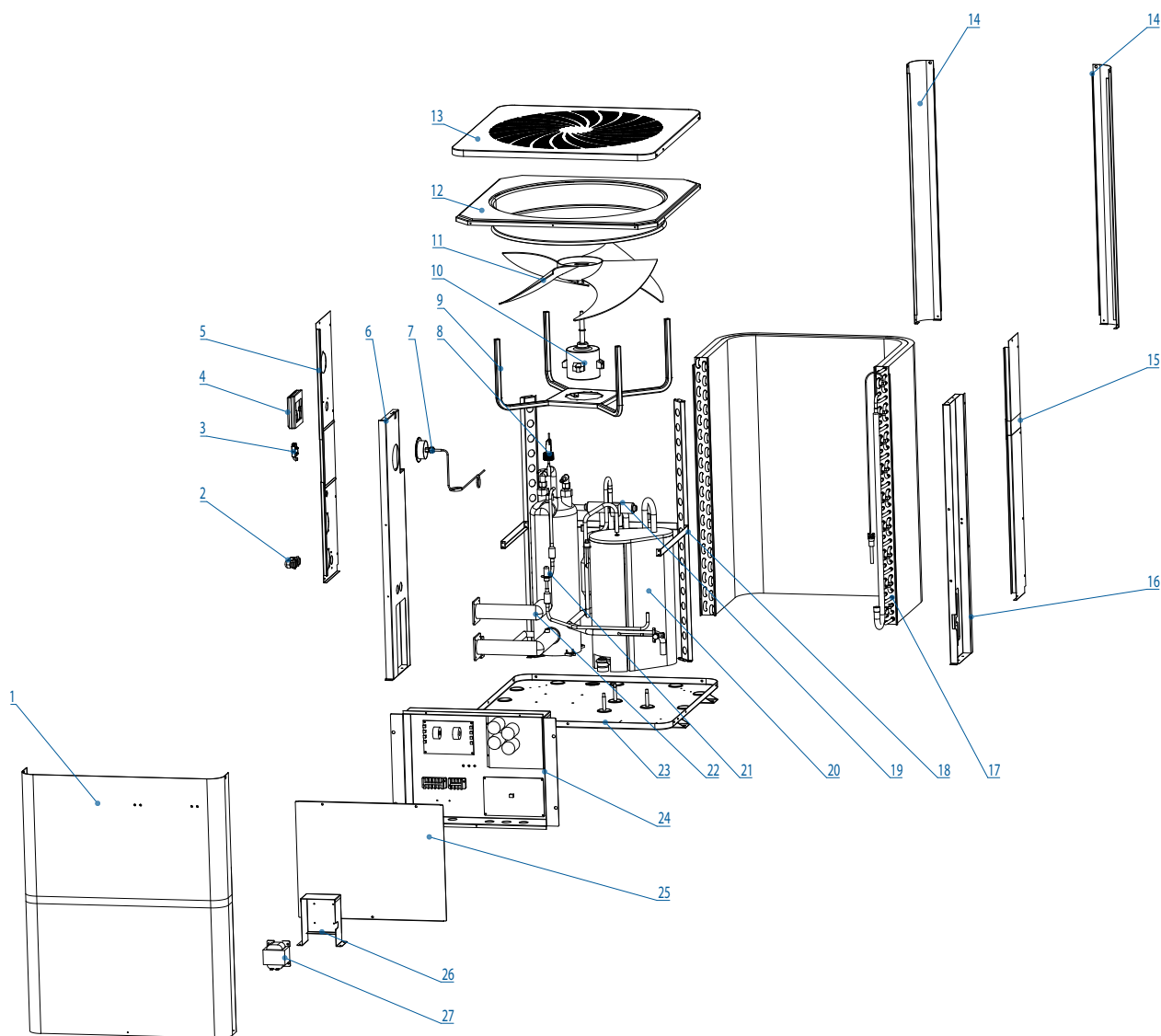

- |                                 |                             |
|---------------------------------|-----------------------------|
| 1. Front panel                  | 14. Fan blade               |
| 2. Electrical control box       | 15. Fan motor               |
| 3. Electrical terminal block    | 16. Fan motor bracket       |
| 4. Electric transformer         | 17. Water Flow Switch       |
| 5. Angular support              | 18. 4-way valve             |
| 6. Bottom panel                 | 19. Left side panel         |
| 7. Electronic expansion valve   | 20. Control panel fix plate |
| 8. Compressor                   | 21. Pressure gauge          |
| 9. Base frame                   | 22. Temp sensor fixing clip |
| 10. Evaporator connection plate | 23. Waterproof connector    |
| 11. Back panel                  | 24. Heat exchanger          |
| 12. Evaporator                  |                             |
| 13. Top panel                   |                             |

# 2. Description

## 2.4 Unit dimensions

### Vertex Fi 3 / 4 / 5 / 6

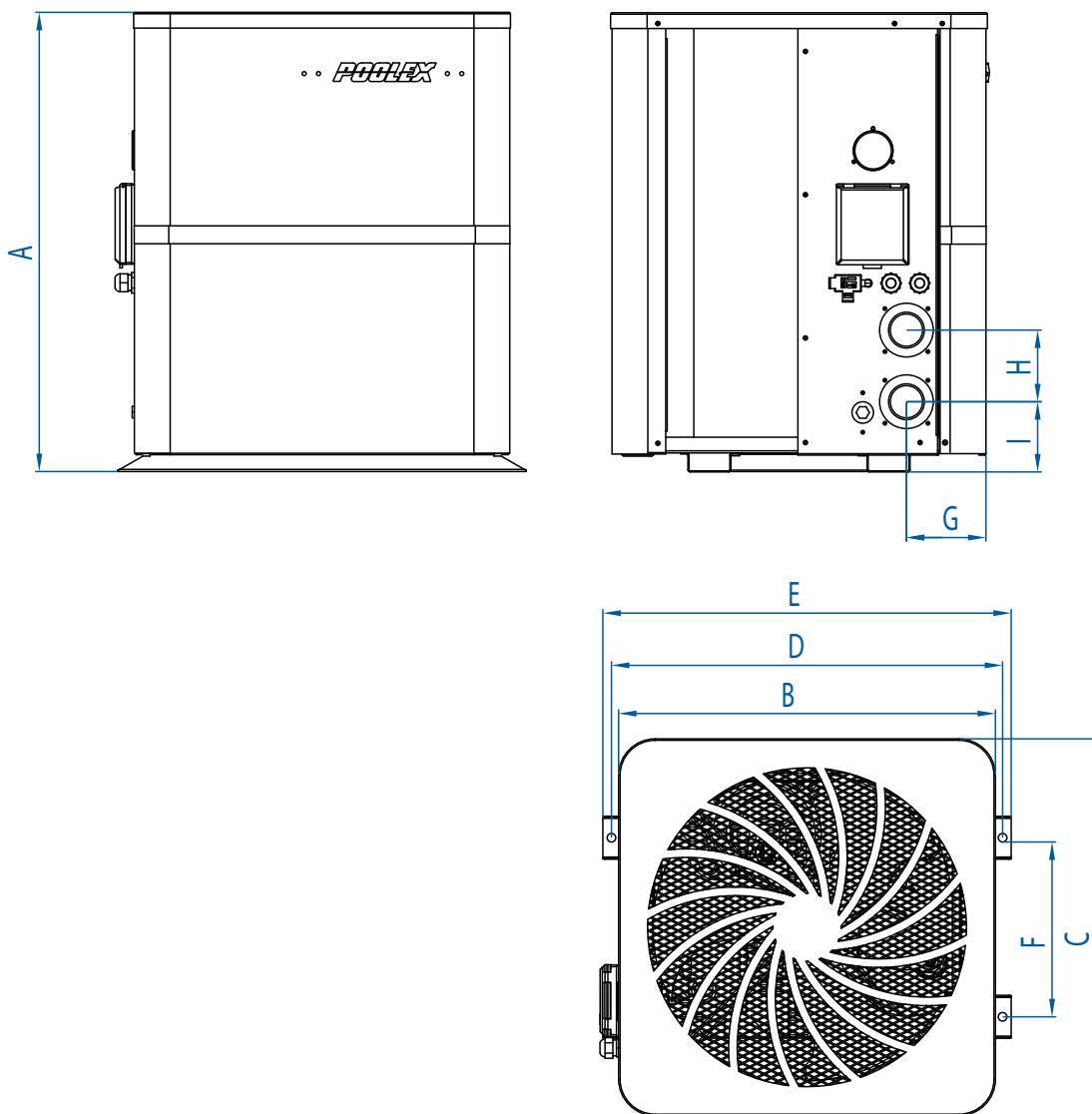

Model	3	4 / 5	6
A	641	740	935
B	526	626	717
C	526	626	717
D	546	656	735
E	570	680	759
F	244	420	390
G	111	142	160
H	100	125	125
I	98	68	93

Dimensions en mm

# 2. Description

## 2.5 Exploded view

### Vertex Fi 3 / 4 / 5 / 6

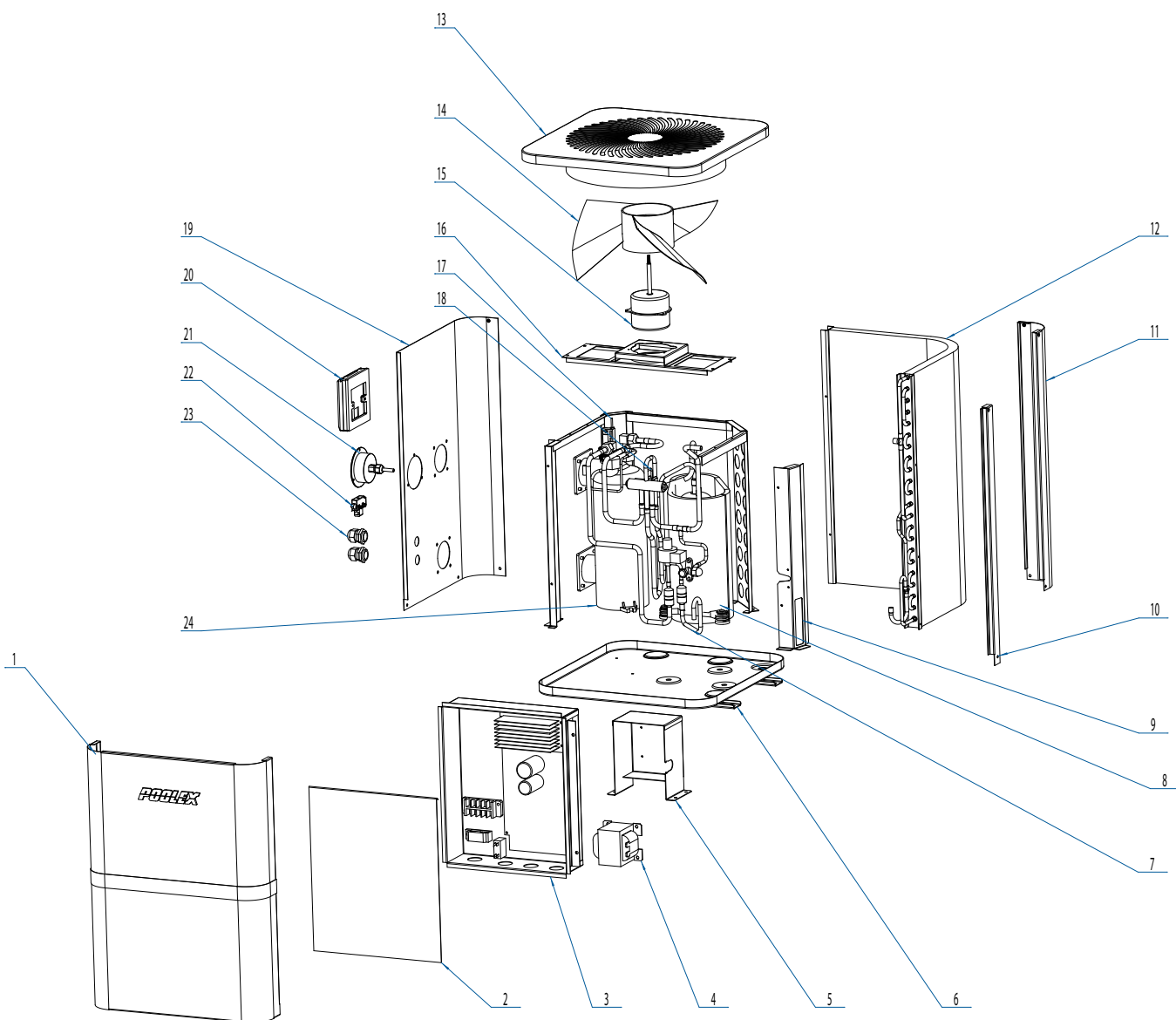

- |                            |                                |
|----------------------------|--------------------------------|
| 1. Front panel             | 15. Right side panel           |
| 2. Waterproof connector    | 16. right side support         |
| 3. Temp sensor fixing clip | 17. Evaporator                 |
| 4. Control panel fix plate | 18. Support                    |
| 5. Left side panel         | 19. 4-way valve                |
| 6. Left side support       | 20. Compressor                 |
| 7. Pressure gauge          | 21. Electronic expansion valve |
| 8. Water Flow Switch       | 22. Heat exchanger             |
| 9. Fan motor bracket       | 23. Bottom panel               |
| 10. Fan motor              | 24. Logic board box            |
| 11. Fan blade              | 25. Electrical box cover       |
| 12. Top Support bracket    | 26. Angular support            |
| 13. Top panel              | 27. Electric transformer       |
| 14. Back panel             |                                |

# 3. Installation



**WARNING: Installation must be carried out by a qualified engineer.**

This section is provided for information purposes only and must be checked and adapted if necessary according to the actual installation conditions.

## 3.1 Pre-requirements

### Equipment necessary for the installation of your heat pump:

Power supply cable suitable for the unit's power requirements.

A *By-Pass* kit and an assembly of PVC tubing suitable for your installation as well as stripper, PVC adhesive and sandpaper.

A set of wall plugs and expansion screws suitable to attach the unit to your support.

We recommend that you connect the unit to your installation by means of flexible PVC pipes in order to reduce the transmission of vibrations.

Suitable fastening studs may be used to raise the unit.

## 3.2 Location

### Please comply with the following rules concerning the choice of heat pump location.

1. The unit's future location must be easily accessible for convenient operation and maintenance.
2. It must be installed on the ground, fixed ideally on a level concrete floor. Ensure that the floor is sufficiently stable and can support the weight of the unit.
3. A water drainage device must be provided close to the unit in order to protect the area where it is installed.
4. If necessary, the unit may be raised by using suitable mounting pads designed to support its weight.
5. Check that the unit is properly ventilated, that the air outlet is not facing the windows of neighbouring buildings and that the exhaust air cannot return. In addition, provide sufficient space around the unit for servicing and maintenance operations.
6. The unit must not be installed in an area exposed to oil, flammable gases, corrosive products, sulphurous compounds or close to high frequency equipment.
7. To prevent mud splashes, do not install the unit near a road or track.
8. To avoid causing nuisance to neighbours, make sure the unit is installed so that it is positioned towards the area that is least sensitive to noise.
9. Keep the unit as much as possible out of the reach of children.

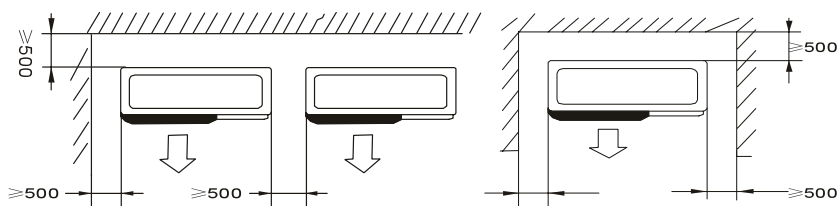

Dimensions in mm.

**Place nothing less than one metre in front of the heat pump.  
Leave 50 cm of empty space around the sides and rear of the heat pump.**

**Do not leave any obstacle above or in front of the unit!**

# 3. Installation

## 3.3 Installation layout

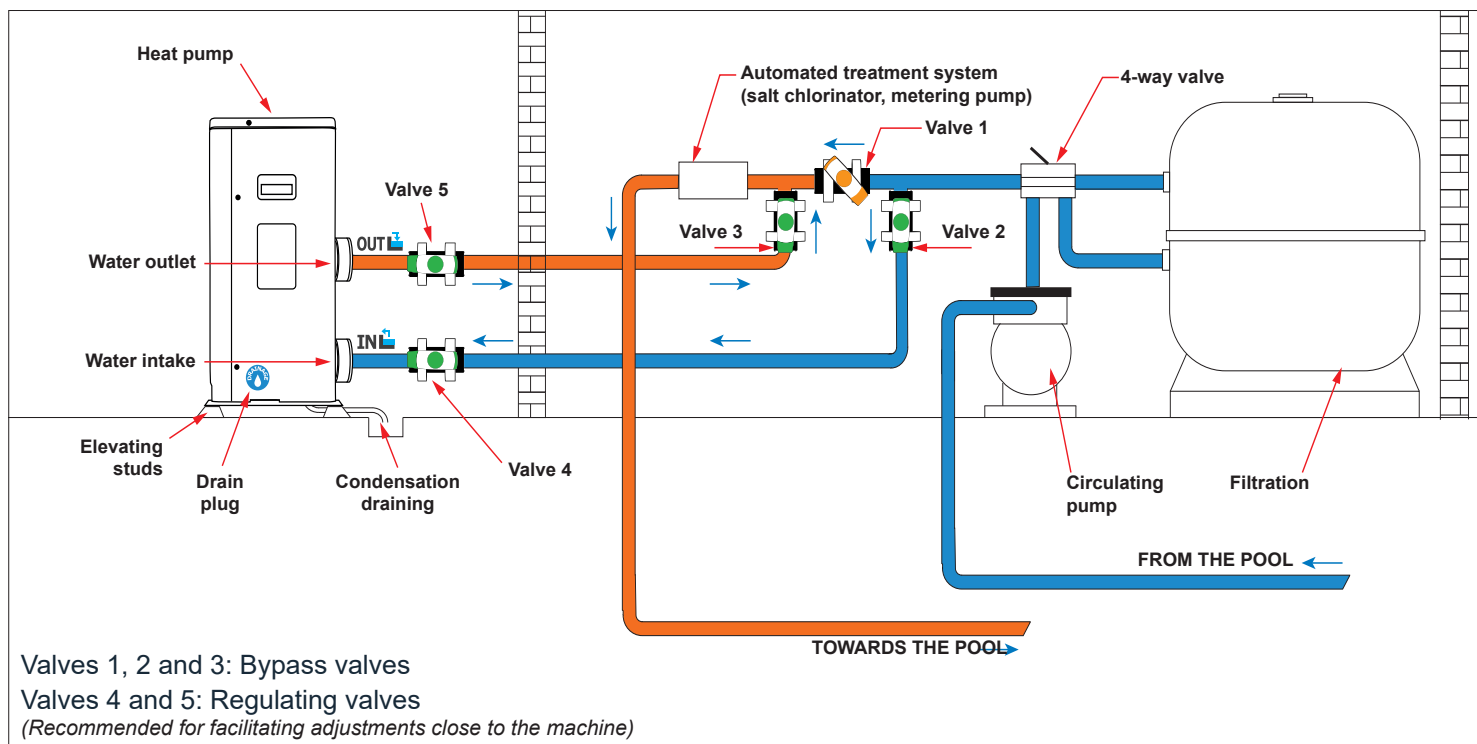

Key



Half-open valve



Open valve

## 3.4 Connecting the condensation draining kit

While operating, the heat pump is subject to condensation. This will result in a more or less large run-off of water, depending on the degree of humidity. To channel this flow, we recommend that you install the condensation drainage kit.

How do you install the condensation drainage kit?

Install the heat pump, raising it at least 10 cm with solid water-resistant pads, then connect the drainage pipe to the opening located under the pump.

## 3.5 Installing the unit on noise-damping supports

In order to minimise the noise pollution associated with heat pump vibrations, it can be positioned on vibration absorbing pads.

To do this, you simply have to position a pad between each of the unit's feet and its support, and then fix the heat pump to the support with suitable screws.

# 3. Installation



**WARNING: Installation must be carried out by a qualified engineer.**

This section is provided for information purposes only and must be checked and adapted if necessary according to the actual installation conditions.

## 3.6 Hydraulic connection

### By-Pass assembly

The heat pump must be connected to the pool by means of a By-Pass assembly.

A By-Pass is an assembly consisting of 3 valves that regulate the flow circulating in the heat pump. During maintenance operations, the By-Pass permits the heat pump to be isolated from the system without interrupting your installation.

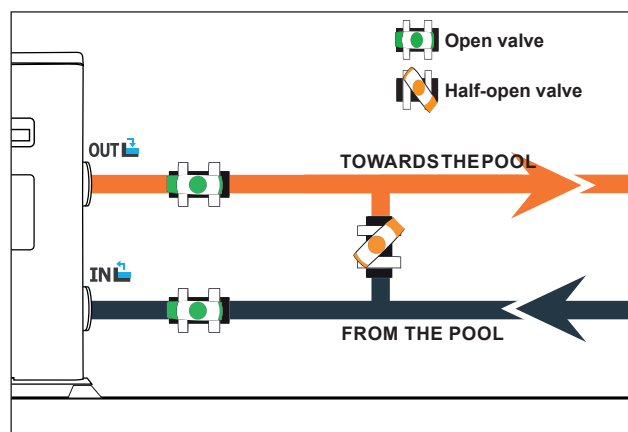

### Making a hydraulic connection with the By-Pass kit



**WARNING: Do not run water through the hydraulic circuit for 2 hours after applying the adhesive.**

Step 1: Take the necessary steps to cut your pipes.

Step 2: Make a straight perpendicular cut through the PVC pipes with a saw.

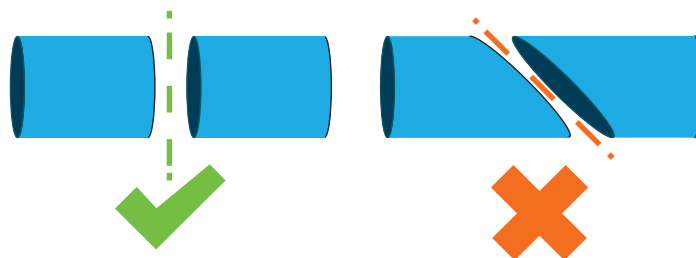

Step 3: Assemble your hydraulic circuit without connecting it in order to check that it perfectly fits your installation, then dismantle the pipes to be connected.

Step 4: Chamfer the ends of the cut pipes with sandpaper.

Step 5: Apply stripper to the ends of the pipes to be connected.

Step 6: Apply the adhesive in the same place.

Step 7: Assemble the pipes.

Step 7: Clean off any adhesive remaining on the PVC.

Step 8: Leave to dry for at least 2 hours before putting the hydraulic circuit into water.



# 3. Installation

## By-Pass assembly for one heat pump

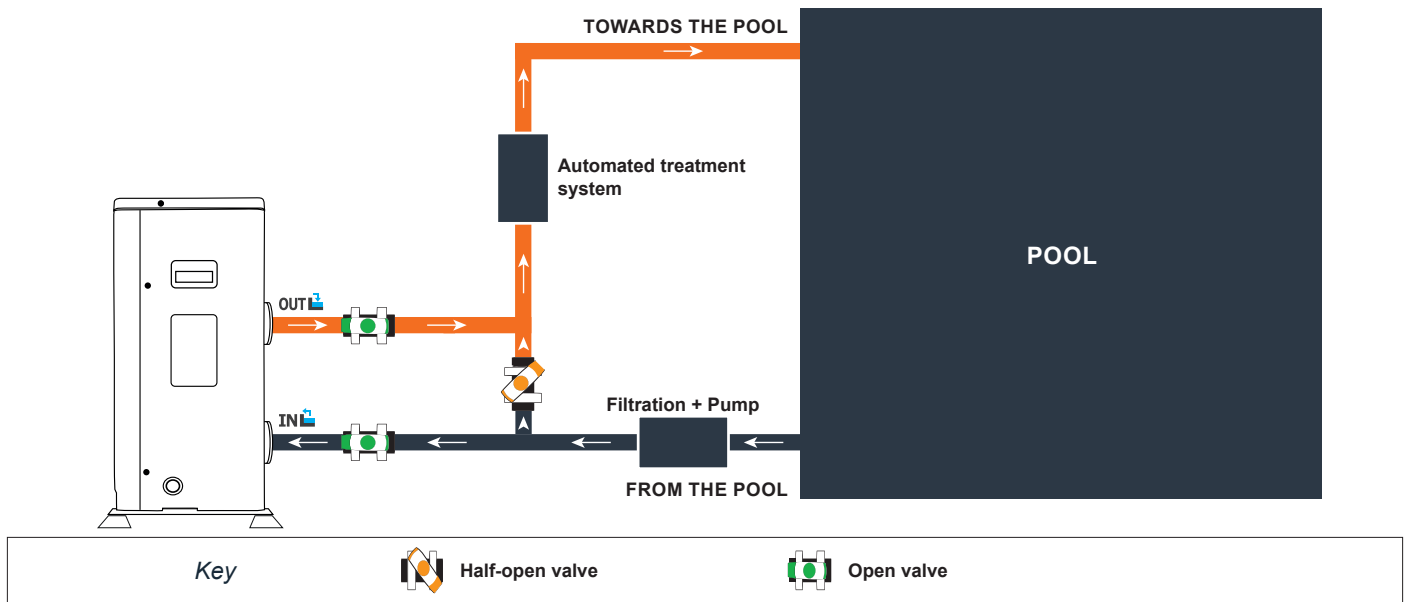

## By-Pass assembly for more than one heat pump

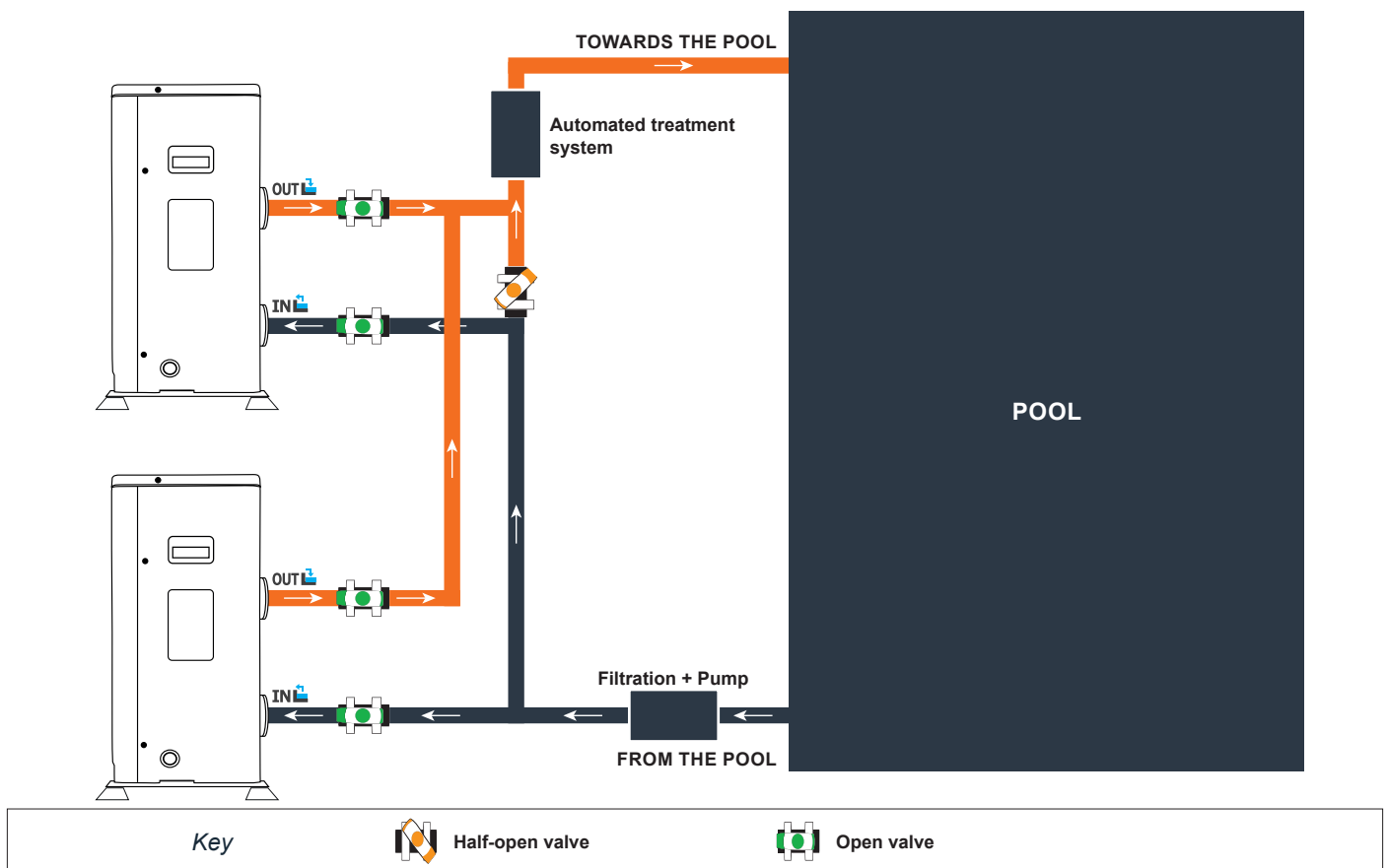

The filter located upstream of the heat pump must be regularly cleared so that the water in the system is clean, thus avoiding the operational problems associated with dirt or clogging in the filter.

# 3. Installation



**WARNING: Installation must be carried out by a qualified engineer.**

This section is provided for information purposes only and must be checked and adapted if necessary according to the actual installation conditions.

## 3.7 Electrical installation

To function safely and maintain the integrity of your electrical system, the unit must be connected to a general electricity supply in accordance with the following regulations:

Upstream, the general electricity supply must be protected by a 30 mA differential switch.

The heat pump must be connected to a suitable D-curve circuit breaker (see table below) in accordance with current standards and regulations in the country where the system is installed.

The electricity supply cable must be adapted to match the unit's rated power and the length of wiring required by the installation (see table below). The cable must be suitable for outdoor use.

For a three-phase system, it is essential to connect the phases in the correct sequence. If the phases are inverted, the heat pump's compressor will not work.

In places open to the public, it is mandatory to install an emergency stop button close to the heat pump.

Models	Electricity supply	Max. current	Cable diameter	Protection Thermal-magnetic (D curve) protection
Vertex Fi 1	Monophasé 220-240V/1N~50Hz	8,4	RO2V 3x2,5 mm <sup>2</sup>	10 A
Vertex Fi 2		12,1	RO2V 3x2,5 mm <sup>2</sup>	16 A
Vertex Fi 3		16,4	RO2V 3x2,5 mm <sup>2</sup>	20 A
Vertex Fi 4		18	RO2V 3x4 mm <sup>2</sup>	20 A
Vertex Fi 5		20,6	RO2V 3x4 mm <sup>2</sup>	25 A
Vertex Fi 6		27,9	RO2V 3x6 mm <sup>2</sup>	32A

<sup>1</sup> Cable cross-section suitable for max. length 10 metres. For longer than 10 metres, consult an electrician.

# 3. Installation

## 3.8 Electrical connection



**WARNING: The heat pump's power supply MUST be disconnected before any operation.**

*Please comply with the following instructions to electrically connect the heat pump.*

**Step 1:** Detach the electrical side panel with a screwdriver to access the electrical terminal block.

**Step 2:** Insert the cable into the heat pump unit by passing it through the opening provided for that purpose.

**Step 3:** Connect the power supply cable to the terminal block in accordance with the diagram below.

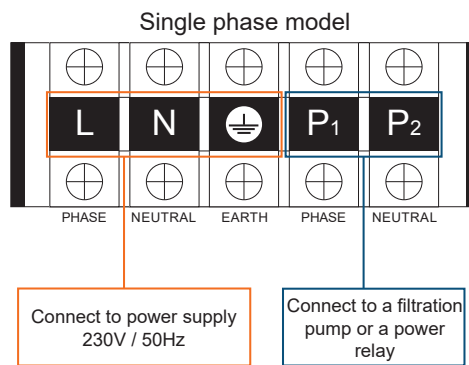

**Step 4:** Carefully close the heat pump panel.

### **Servo-control of circulating pump**

Depending on the type of installation, you can also connect a circulating pump to terminals P1 and P2 so that this operates in tandem with the heat pump.



**WARNING: Servo-control of a pump whose power exceeds 5A (1000W) requires the use of a power relay.**

# 4. Use

## 4.1 Wired remote control

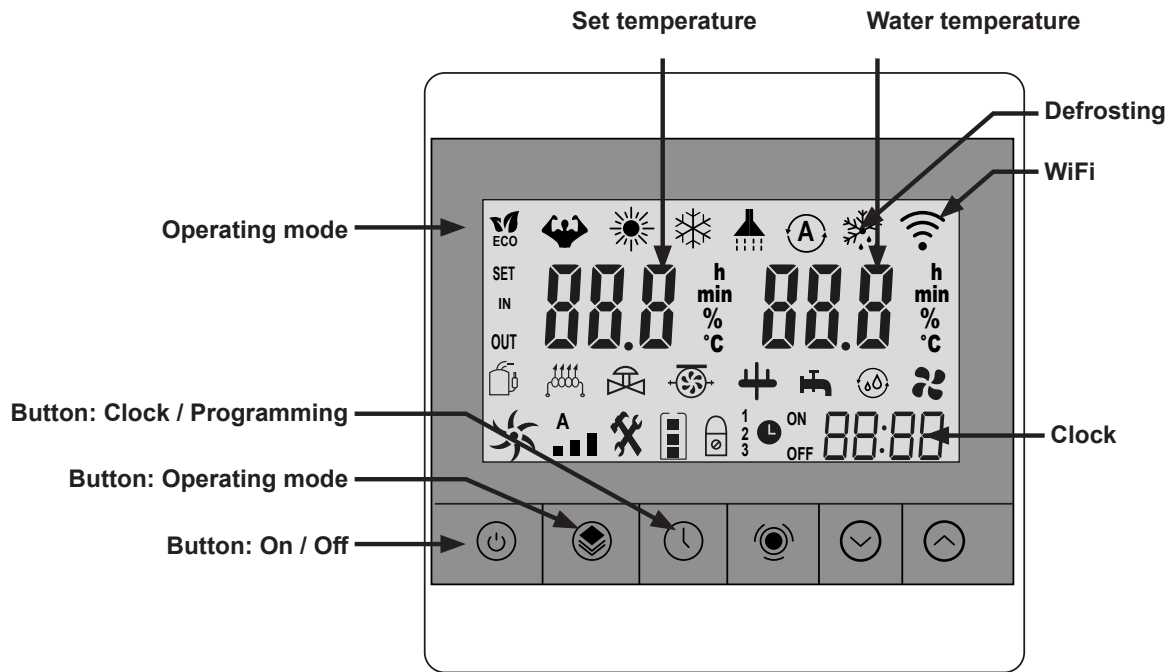

Before you start, make sure the filtration pump is running and that water is flowing through the heat pump.



Before setting your set temperature, you must choose the operating mode of your heat pump first

### Other indications of the control box



This icon represents the compressor, it is displayed when the compressor is running. Cette icon



represents the fan, it is displayed when the fan is on.



This icon represents the 4-way valve, it is displayed when the valve is on.

**IN**

This icon is displayed when checking the inlet water temperature.





This icon indicates the fan rotation speed.

# 4. Use

## 4.2 Start-up and locking

Press the button  to switch the heat pump on or off. This button is also used to return to the main interface.

When the heat pump is in operation, press the button  for 5 seconds to lock or unlock the housing. (The lock is activated automatically after 60 seconds of inactivity). When the case is locked, the logo  appears.

## 4.3 Operating mode selector

Press the button  to change the operating mode :



### *Mode Eco Inverter :*

Choose this heating mode so that the heat pump operates silently.

### *Mode Boost Inverter :*

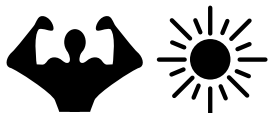

Choose this heating mode so that the heat pump intelligently heats the water in your pool in inverter mode.

### *Mode Refroidissement (inverter) :*



Choose the cooling mode so that the heat pump intelligently cools the water in your pool.



### *Automatic mode (inverter):*

Choose automatic mode for the heat pump to intelligently change operating mode according to the set temperature.

### WiFi connection

Your heat pump is equipped with WiFi as standard for remote control.

To learn more about WiFi pairing and control, go to your product page on

[www.poolex.fr](http://www.poolex.fr)



# 4. Use

## 4.5 Choice of operating mode



**WARNING:** Before starting, ensure that the filtration pump is operating correctly.

**Step 1 :** Go to the main menu by unlocking the control panel.

**Étape 2 :** Presse the button  to switch between the 3 operating modes: Eco Inverter, Boost Inverter, refroidissement.

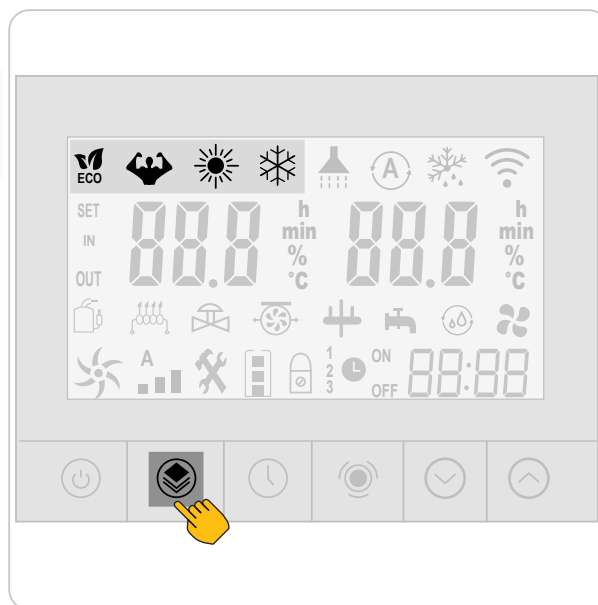

### Good to know



**WARNING:** When the cooling mode switches to heating mode or vice-versa, the heat pump will restart after 10 minutes.

When the incoming water temperature is less than or equal to the required temperature (setpoint temperature - 1°C), the heat pump will switch to heating mode. The compressor will stop when the temperature of the incoming water is greater than or equal to the required temperature (setpoint temperature + 1°C).

## 4.6 Setting the required temperature

**Step 1 :** Go to the main menu by unlocking the control panel.

**Step 2 :** Press buttons  and  to change the set temperature.

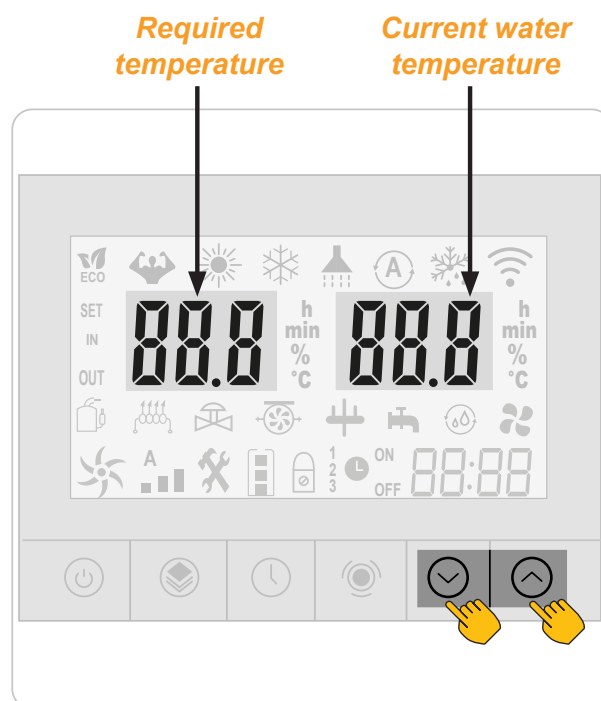



# 4. Use

## 4.7 Clock setting

**Step 1 :** Go to the main menu by unlocking the control panel.

**Step 2 :** Push the button  to enter the clock setting interface. Clock display **88:88** flashes.

**Step 3 :** Change the hours using the buttons  and .

**Step 4 :** Press again  to go to minute setting. Change the minutes using the buttons  and .

**Step 5 :** Press again  to confirm the setting and return to the main menu.

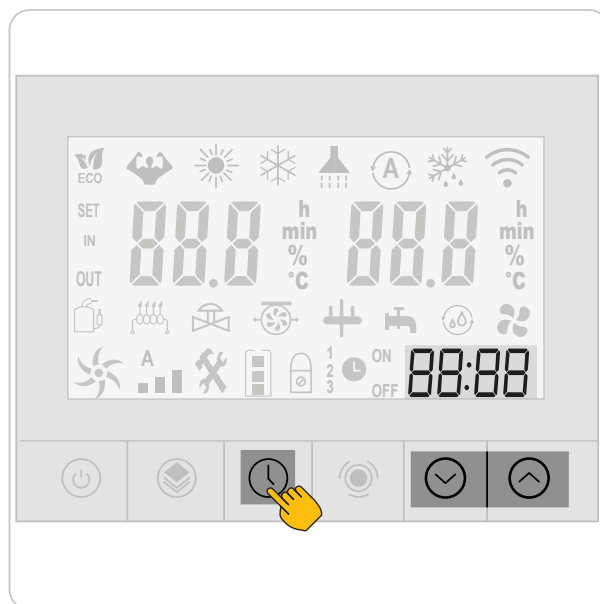

## 4.8 On / Off synchronization adjustment



This function is used to program the start and stop time. You can program up to 3 different starts and stops. The setting is done as follows:

**Step 1 :** Go to the main menu by unlocking the control panel.

**Step 2 :** Press the button for 5 seconds  to enter the setting of the On / off groups.

**Step 3 :**  **88:88** Group 1 is displayed as well as the ON action mode.

**Step 4 :** Change the hours using the buttons  and .

**Step 5 :** Press again  to go to minute setting. Change the minutes using the buttons  and .

**Step 6 :** Press again  to go to stop time " OFF "

 **88:88** and repeat steps 4 and 5.

**Step 7 :** To go to group 2 and 3 press the button  and repeat steps 4, 5 and 6.

**Step 8 :** Push the button  to confirm the settings and return to the main menu.

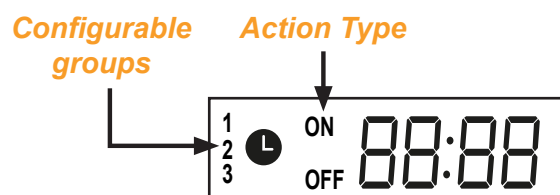
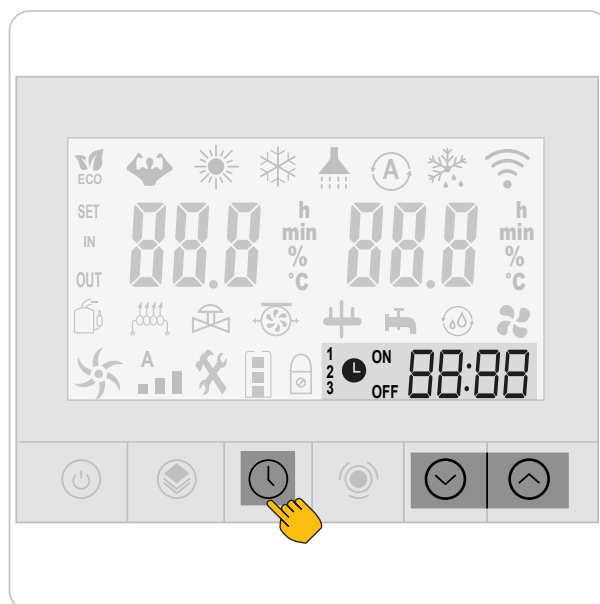

# 4. Use

## 4.9 Activation / deactivation of On / Off groups

Groups can be activated / deactivated at any time. The setting is as follows:

**Step 1 :** Go to the main menu by unlocking the control panel.

**Step 2 :** Press the button  for 5 seconds to enter the setting of the On / off groups.

**Step 3 :** Set the same time for switching on (ON) and switching off (OFF) to deactivate the selected group.

**Step 4 :** Press the button  to confirm the settings and return to the main menu.

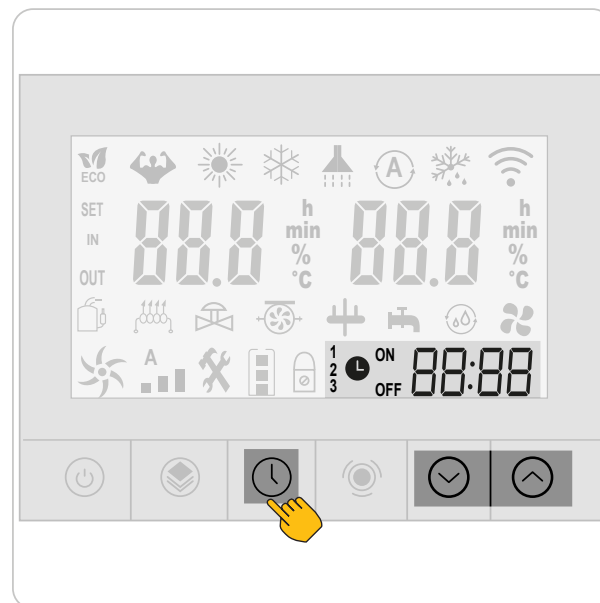

## 4.10 Main parameters









**WARNING :** This operation is used to facilitate maintenance and future repairs.  
Only an experienced professional is authorized to modify the default parameters

System settings can be checked and changed using the remote control by following the steps below

**Step 1 :** Press the button  once to enter the general parameters of the heat pump.

The icon **SET** is displayed.

**Step 2 :** Scroll through the main parameter codes using the and buttons  and  and confirm by pressing .

**Step 3 :** To modify the selected parameter, use the buttons  and  then confirm by pressing .

**Step 4 :** Press the button  to return to the main menu.

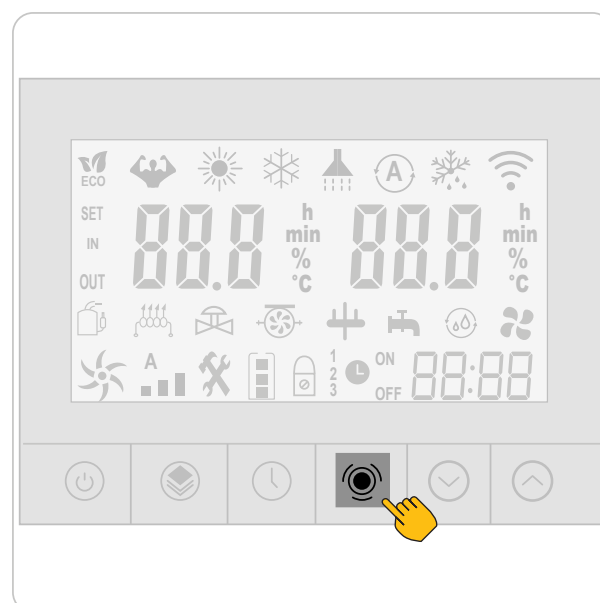



# 4. Use

**Table of main parameters**

N°	Description	Default value	Variation
P01	Adjusting the heating temperature	27°C	15 - 40°C
P02	Adjusting the cooling temperature	27°C	8 - 28°C
P03	Changing the temperature in automatic mode	27°C	8 - 40°C
P04	Adjustment of temperature difference before restart	1°C	1-18°C
P05	Filter pump control	1	0 = ON; 1 = Runs for 2 minutes every hour

## 4.11 Parameter checking

N°	Description	Default value
C01	Ambient temperature	°C
C02	evaporator coil temperature	°C
C03	absorb temperature	°C
C04	exhaust temperature	°C
C05	reserved	°C
C06	reserved	°C
C07	Titanium heat exchanger temperature	°C
C08	water inlet temperature	°C
C09	water outlet temperture	°C
C10	reserved	°C
C11	reserved	°C
C12	reserved	
C13	temperature sensor failure	
C14	Refrigerant system failure	
C15	Inverter driver failure	
C16	signal output	
C17	running status	
C18	AC voltage	V
C19	DC voltage	V
C20	Actual frequency	Hz
C21	EEV open degree	
C22	reserved	
C23	heat pump current	A
C24	compressor current	A
C25	dc fan motor speed	

# 5. Operation

## 5.1 Operation

### *Conditions of use*

For the heat pump to operate normally, the ambient air temperature must be between -5°C and 43°C.

### *Recommendations prior to start-up*

Before activating the heat pump, please:

- ✓ Check that the unit is firmly secured and stable.
- ✓ Check that the gauge indicates a pressure greater than 80 psi.
- ✓ Check that the electrical wiring is properly connected to the terminals.
- ✓ Check the earthing.
- ✓ Check that the hydraulic connections are tight and that there is no leakage of water.
- ✓ Check that the water is circulating correctly in the heat pump and that the flow rate is adequate.
- ✓ Remove any unnecessary object or tool from around the unit.

### *Operation*

1. Activate the unit's power supply protection (differential switch and circuit-breaker).
2. Activate the circulating pump if it is not servo-controlled.
3. Check the By-Pass opening and the control valves.
4. Activate the heat pump by pressing once on 
5. Adjust the remote control clock.
6. Select the required temperature by using one of the remote control's mode.
7. The heat pump's compressor will start up after a few moments.

All you have to do now is wait until the required temperature is reached.



**WARNING:** Under normal conditions, a suitable heat pump can heat the water in a swimming pool by 1°C to 2°C per day. It is therefore quite normal to not feel any temperature difference in the system when the heat pump is working.  
A heated pool must be covered to avoid any loss of heat.

## 5.2 Servo-control of circulating pump

If you have connected a circulating pump to terminals P1 and P2, it is automatically electrically powered when the heat pump operates.

# 5. Operation

## 5.3 Using the pressure gauge

The gauge is for monitoring the pressure of the refrigerant contained in the heat pump. The values it indicates can vary considerably, depending on the climate, temperature and atmospheric pressure.

### **When the heat pump is in operation:**

The gauge's needle indicates the refrigerant pressure.

*Mean operating range between 250 and 400 PSI, depending on the ambient temperature and atmospheric pressure.*

### **When the heat pump is shut down:**

The needle indicates the same value as the ambient temperature (within a few degrees) and the corresponding atmospheric pressure (between 150 and 350 PSI maximum).

### **If left unused for a long period of time :**

Check the pressure gauge before starting up the heat pump. It must indicate at least 80 PSI.

If the pressure goes down too much, the heat pump will display an error message and automatically go into 'safe' mode.

This means that there has been a leakage of refrigerant and that you must call a qualified technician to replace it.

## 5.4 Antifreeze protection



**WARNING: For the antifreeze system to work, the heat pump must be powered and the circulating pump activated. If the circulating pump is servo-controlled by the heat pump, it will be automatically activated.**

When the heat pump is on standby, the system monitors the ambient temperature and the water temperature in order to activate the antifreeze programme if required.

The antifreeze programme is automatically activated when the ambient temperature or the temperature of the water is less than 2°C and when the heat pump has been shut down for more than 120 minutes.

When the antifreeze programme is running, the heat pump activates its compressor and the circulating pump so as to reheat the water until the water temperature exceeds 2°C.

The heat pump automatically leaves the antifreeze mode when the ambient temperature is greater than or equal to 2°C or when the heat pump is activated by the user.

# 6. Maintenance and servicing

## 6.1 Maintenance and servicing



**WARNING: Before undertaking maintenance work on the unit, ensure that you have disconnected the electrical power supply.**

### Cleaning

The heat pump's casing must be cleaned with a damp cloth. The use of detergents or other household products could damage the surface of the casing and affect its properties.

The evaporator at the rear of the heat pump must be carefully cleaned with a vacuum cleaner and soft brush attachment.

### Annual maintenance

The following operations must be undertaken by a qualified person at least once a year.

- ✓ Carry out safety checks.
- ✓ Check the integrity of the electrical wiring.
- ✓ Check the earthing connections.
- ✓ Monitor the state of the pressure gauge and the presence of refrigerant.

## 6.2 Winter storage

In the winter months when the ambient temperature is lower than 3°C, a shut-down heat pump must be winterised to avoid any frost damage.

### Winterising in 4 steps



**Step 1**  
Disconnect the heat pump from the power supply.

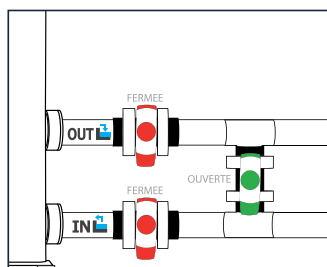

**Step 2**  
Open the By-Pass valve. Close the inlet and outlet valves.

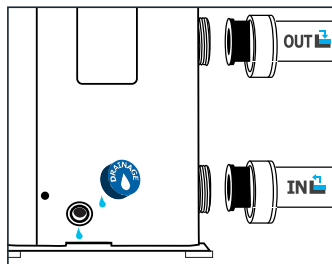

**Step 3**  
Unscrew the drain plug and water pipes in order to drain any water from the heat pump.

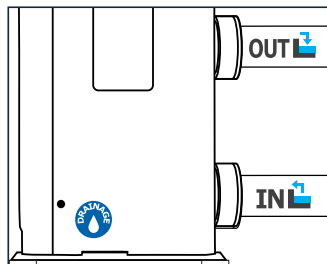

**Step 4**  
Screw back the drain plug and pipes or block them with rags so as to prevent any foreign bodies from getting into the circuit. Finally, protect the pump with its winter storage cover.



**If a circulating pump is servo-controlled by the heat pump, drain this also.**

# 7. Repairs



**WARNING:** Under normal conditions, a suitable heat pump can heat the water in a swimming pool by 1°C to 2°C per day. It is therefore quite normal to not feel any temperature difference in the system when the heat pump is working.  
A heated pool must be covered to avoid any loss of heat.

## 7.1 Breakdowns and faults

In the event of a problem, the heat pump's screen displays a fault symbol  instead of temperature indications. Please consult the table opposite to find the possible causes of a fault and the actions to be taken.

Fault code examples:

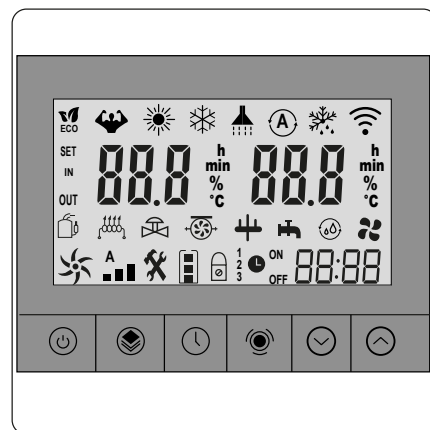

## 7.2 Advanced status values settings





**WARNING :** This is to facilitate maintenance and future repairs.  
Only an experienced professional is authorized to modify the default parameters.



**WARNING :** Any modification of the parameters reserved automatically results in the cancellation of the guarantee.

System settings can be checked and changed using the remote control by following the steps below

**Step 1 :** Press both  for 3 seconds to enter the advanced settings menu. The icon **SET** is displayed.

**Step 2 :** Scroll through the main parameter codes using the buttons  and .

**Step 3 :** Press the button  to return to the main menu.

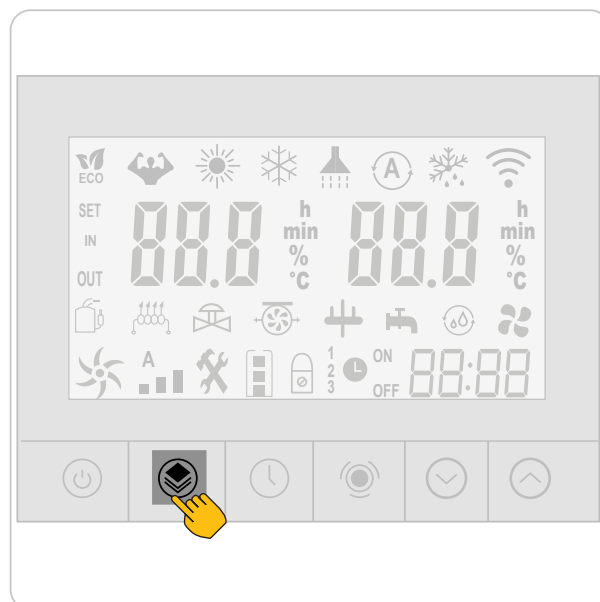

# 7. Repairs

## 7.3 List of faults

Code	Anomalies	Causes possibles	Actions
	Flow sensor malfunction	Insufficient water in heat exchanger	Check your water circuit operation and the opening of the By-Pass valves
		Sensor disconnected or defective	Reconnect or replace sensor
E04	Antifreeze protection	Protection activated when the ambient temperature is too low and the unit is on standby	No intervention is necessary
E05 E06	High or low pressure protection	Insufficient water flow	Check water pump operation and openings of By-Pass inlet/outlet valves
		Excess refrigerant gas	Readjust the refrigerant volume
		Defective 4-way valve	Replace the 4-way valve
		High pressure switch disconnected or defective	Reconnect or replace high pressure switch
E09	Connection problem between PCB and wired remote control	Bad connection	Check wiring connections between remote control and PCB
		Defective wired remote control	Replace remote control
		Defective PCB	Replace PCB
E10	Connection problem between PCB and inverter module	Bad connection	Check wiring connections between PCB and inverter module
		Defective inverter module	Replace inverter module
		Defective PCB	Replace PCB
E12	Vented air temperature too high	Insufficient refrigerant gas	Readjust the refrigerant volume
E15	Water intake temperature sensor malfunction	Sensor disconnected or defective	Reconnect or replace sensor
E16	Outside coil temperature error	Sensor disconnected or defective	Reconnect or replace sensor
E18	Vented temperature error	Sensor disconnected or defective	Reconnect or replace sensor
E20	Inverter module protection	See chapter Appendices	
E21	Ambient temperature error	Sensor disconnected or defective	Reconnect or replace sensor
E23	Water temperature at outlet too low for cooling mode	Insufficient water flow	Check water pump operation and openings of By-Pass inlet/outlet valves
E27	Water outlet error	Sensor disconnected or defective	Reconnect or replace sensor
E29	Backed temperature error	Sensor disconnected or defective	Reconnect or replace sensor
E32	Outlet temperature too high for heating mode protection	Insufficient water flow	Check water pump operation and openings of By-Pass inlet/outlet valves
E33	Coil temp too high (higher than 60°C) for cooling mode protection	Refrigerant overcharged	Readjust the refrigerant volume
		Fan motor doesn't work or air outlet blocked	Check the fan is working properly and the air inlet is unobstructed
E42	Inside coil temperature error	Sensor disconnected or defective	Reconnect or replace sensor
E46	DC fan motor malfunction	Bad wire connection	Reconnect the fan
		Fan motor is defective	Replace the fan motor

# 8. Recycling

## 8.1 Recycling the heat pump

Your heat pump has reached the end of its life and you wish to dispose of it or to replace it. Do not throw it in the rubbish bin.

A heat pump must be disposed of separately with a view to its reuse, recycling or upgrading. It contains substances that are potentially hazardous to the environment but which will be eliminated or neutralised by recycling.

### YOU HAVE THREE SOLUTIONS:

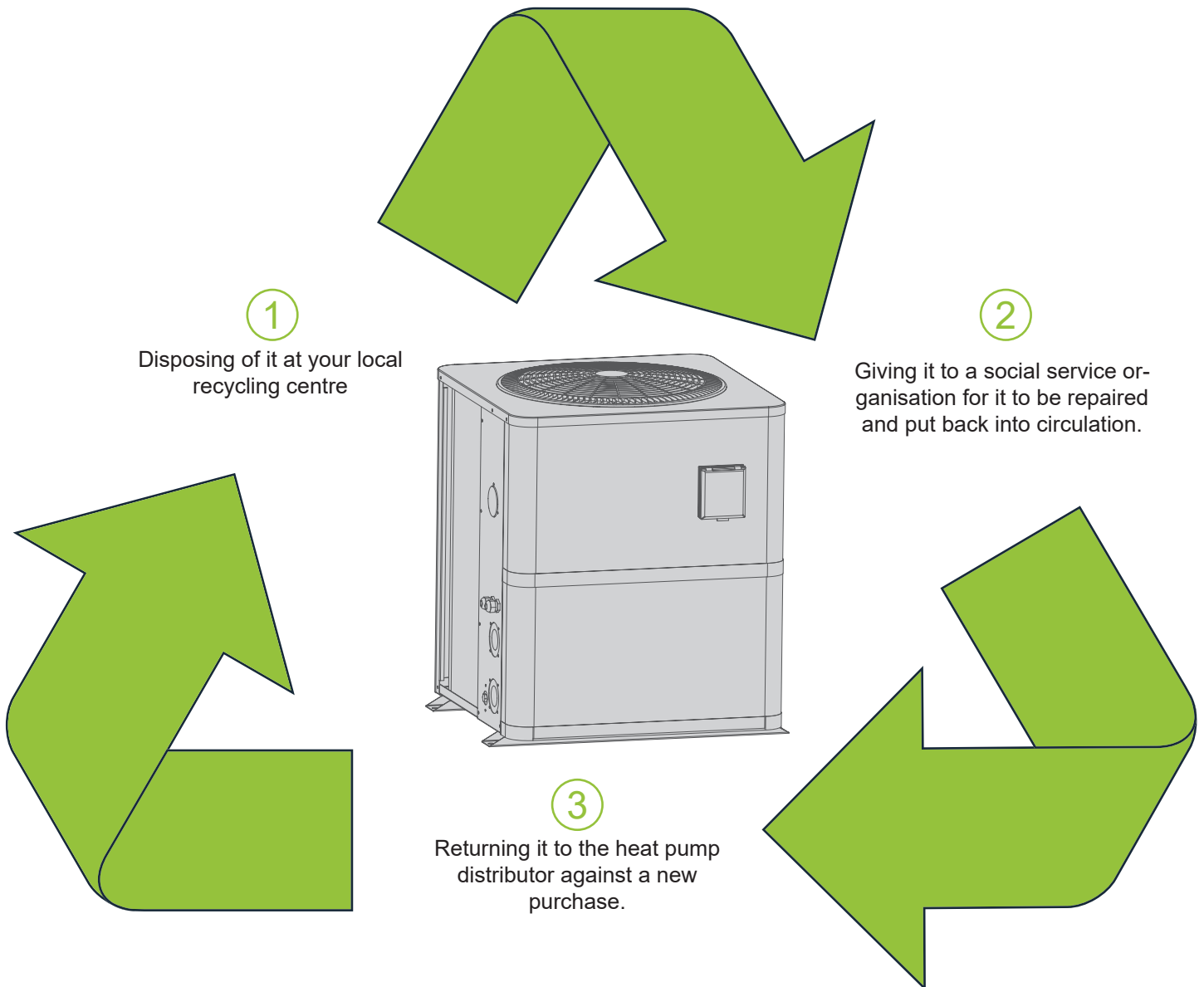

# 9. Warranty

## 9.1 General warranty conditions

The Poolstar Company guarantees the original owner against defective materials and faults in the manufacture of the Poolex heat pump for a period of two (2) years.

The compressor is guaranteed for a period of Five (5) years.

The titanium tube heat exchanger is guaranteed for a period of fifteen (15) years against chemical corrosion, except for frost damage.

The condenser's other components are guaranteed for two (2) years.

The warranty becomes effective on the date of the first invoice.

The warranty does not apply in the following cases:

- Malfunction or damage arising from an installation, usage or repair that is not in compliance with the safety instructions.
- Malfunction or damage arising from a chemical agent that is unsuitable for the pool.
- Malfunction or damage arising from conditions that are unsuitable for the equipment's purposes of use.
- Damage arising from negligence, accident or force majeure.
- Malfunction or damage arising from the use of unauthorised accessories.

Repairs undertaken during the warranty period must be approved prior to being carried out by an authorised technician. The warranty shall be null and void if the repair to the equipment is carried out by a person who is not authorised by the Poolex company.

The guaranteed parts shall be replaced or repaired at Poolex's discretion. Defective parts must be returned to our workshops to be covered during the warranty period. The warranty does not cover labour costs or unauthorised replacements. The return of the defective part is not covered by the warranty.



# 10. Appendices

## 10.1 Wiring diagrams

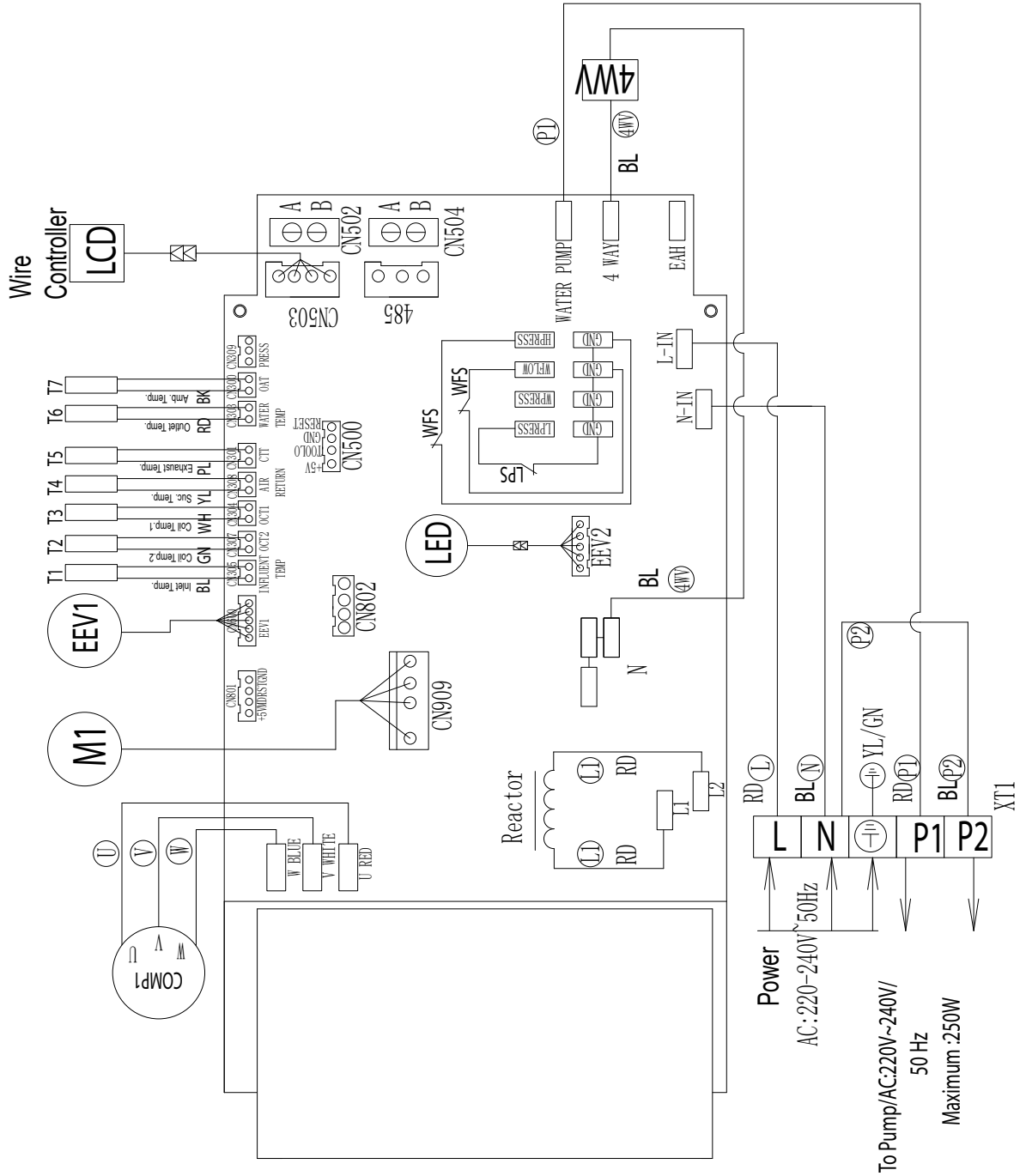

WIRE COLOR CODE	Full name
BK BLACK	Outlet water temperature sensor
PL PURPLE	Inlet water temperature sensor
BL BLUE	Suction temperature sensor
RD RED	Exhaust temperature sensor
WH/WHITE	Ambient temperature sensor
GN GREEN	Coil temperature sensor 2
YL YELLOW	Coil temperature sensor 1
MF	Constant Current Motor Fan
4W	4 way valve
HPS	High pressure switch
LPS	Low pressure switch
WFS	Water flow switch
COMP	Compressor
LED	LED Lamp
XT1	Terminal
EEV1	Electronic Expansion Valve
Abbreviation	

# 10. Appendices

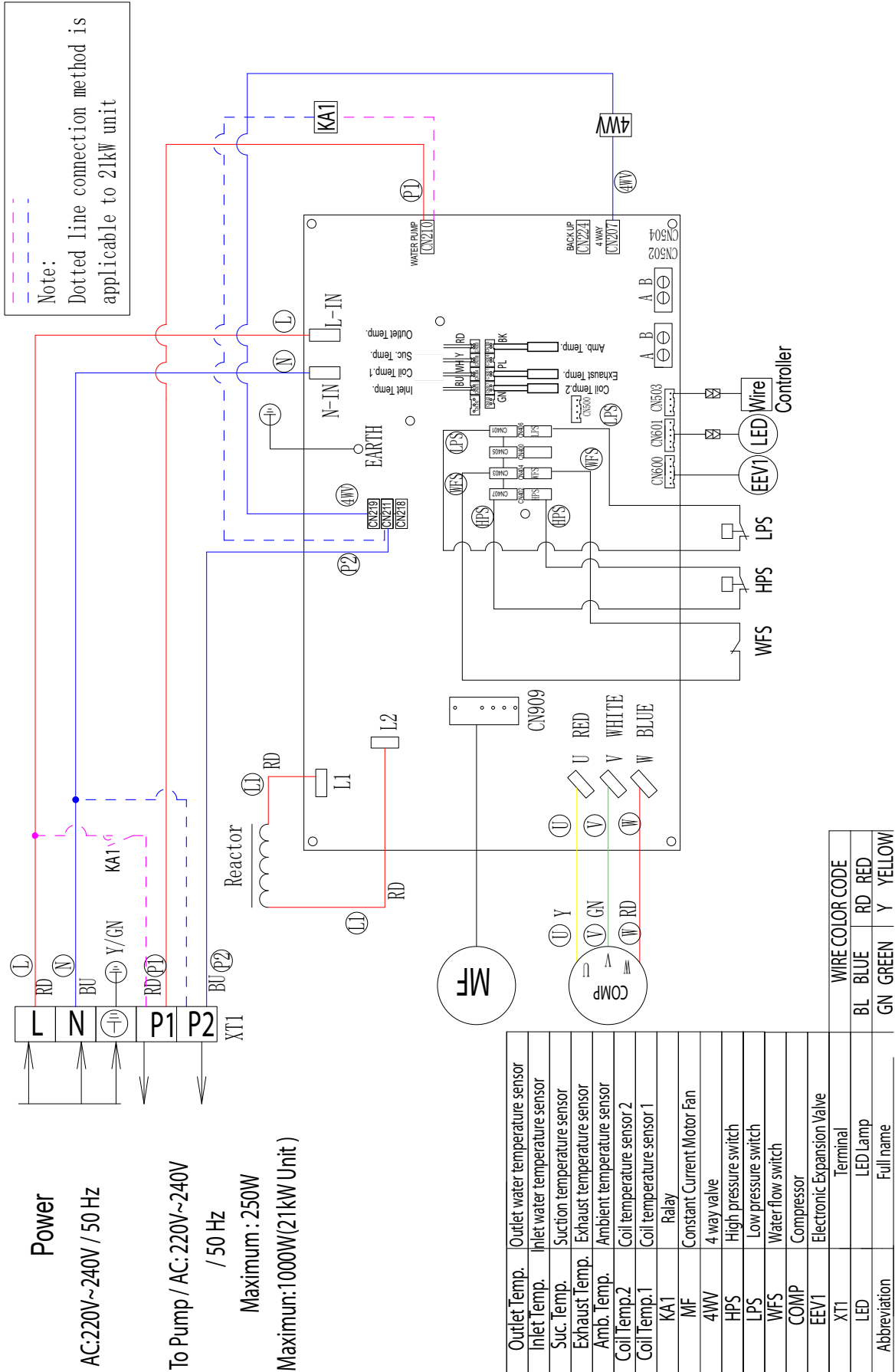

# 10. Appendices

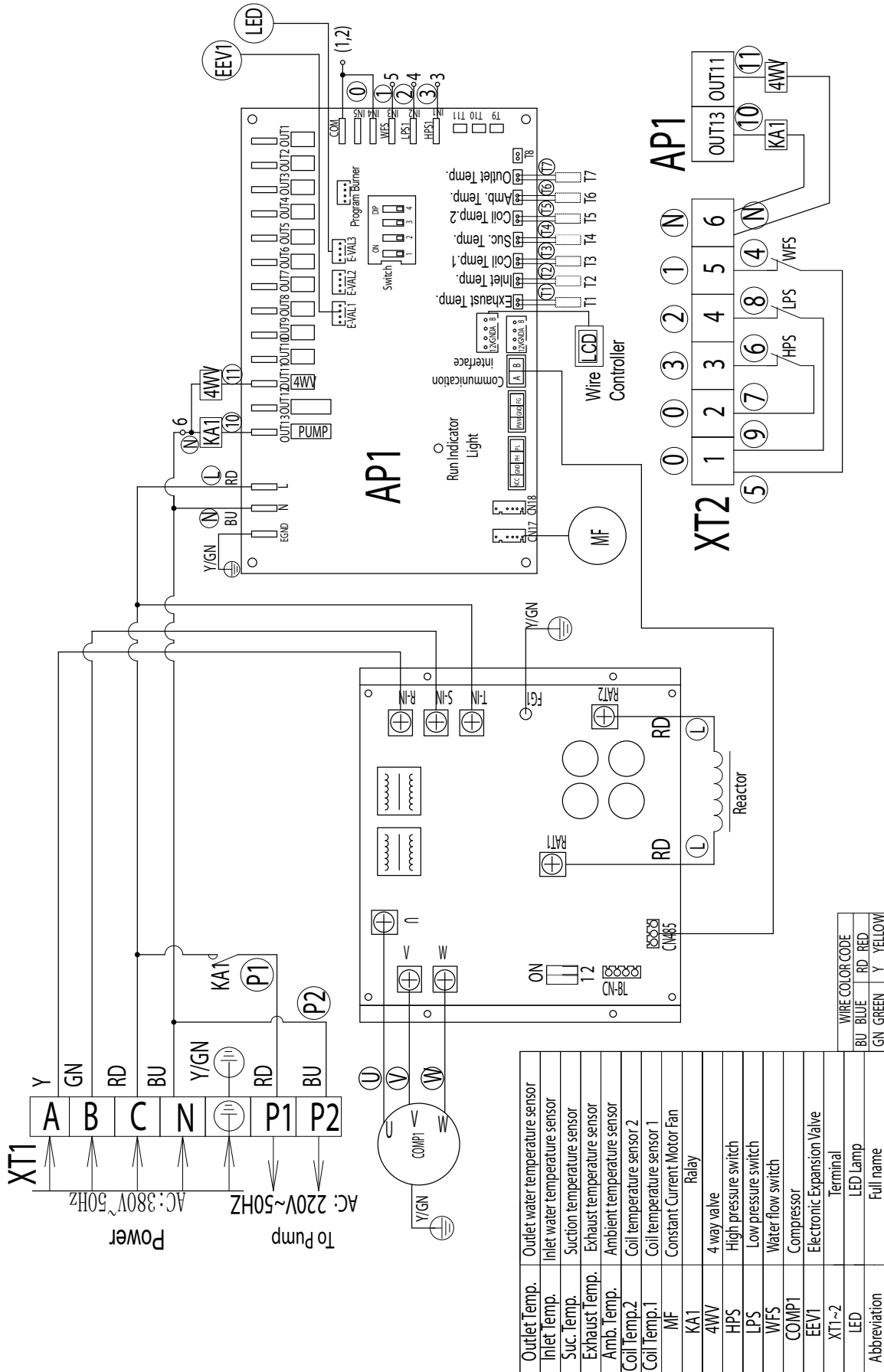

# **POOLEX**

## Vertex **FI**

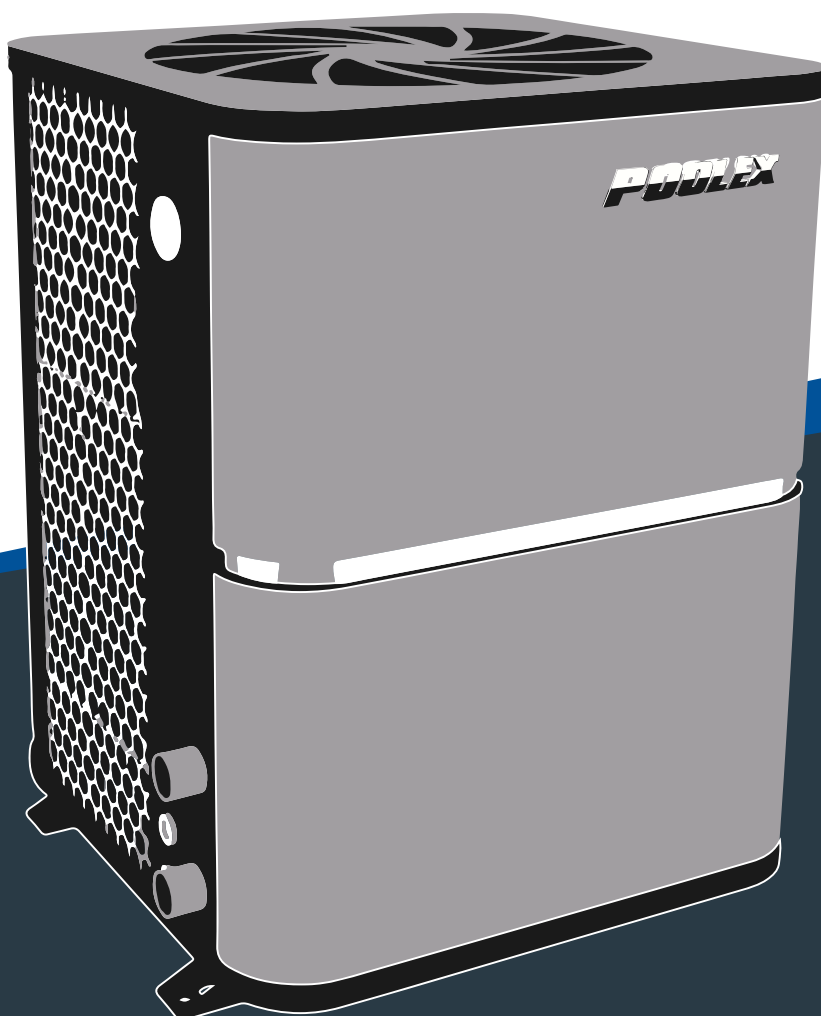

✓ **RoHS**

**CE**

02-2021